

# TS.11205 Slide Arm Closer

Power Adjustable  
EN2-5 by  
Spring

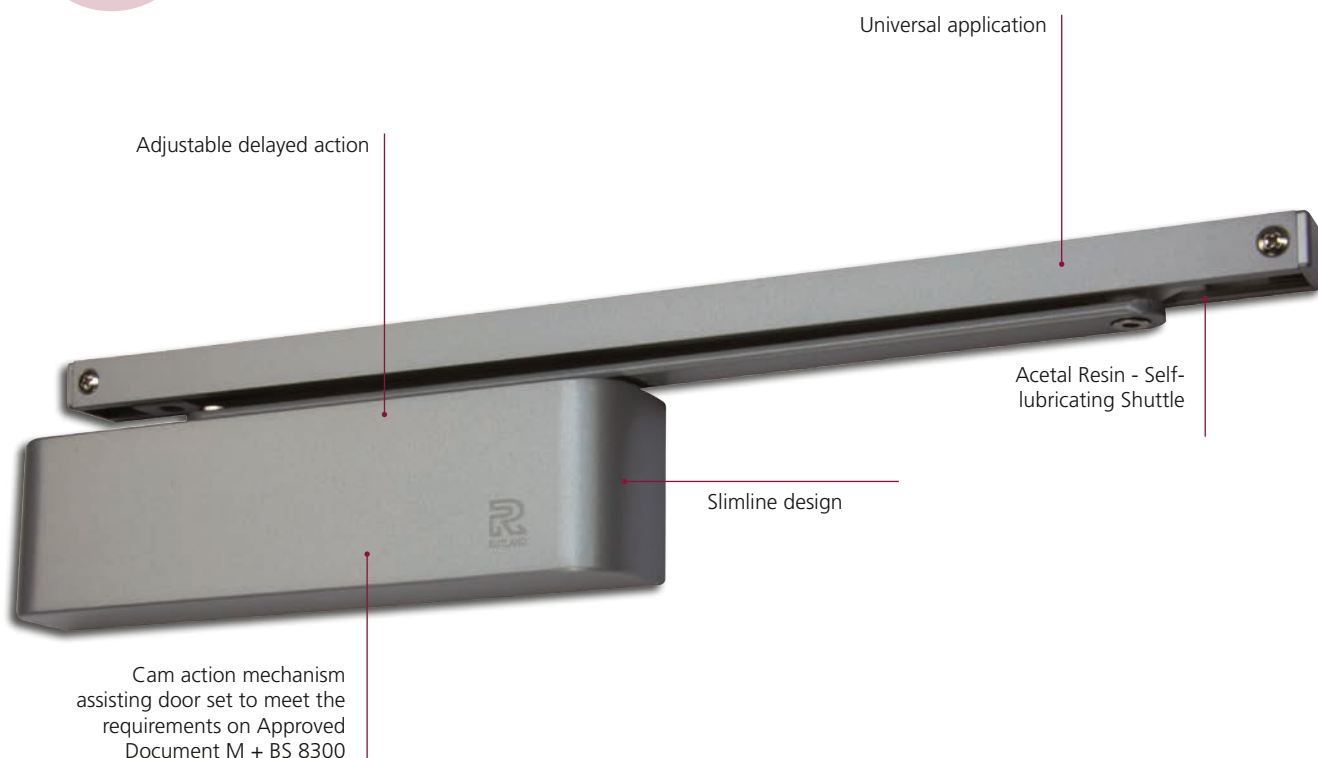

Silver (SE)



Satin Nickel Plate (SNP)



Polished Nickel Plate (PNP)



Electro Brass (PVD)

## Product Overview

- ✓ Variable power size EN 2-5
- ✓ CE marked and UL listed
- ✓ Universal fitting
- ✓ Available with back check and adjustable delayed action
- ✓ Easy to read instructions, saving 12 minutes of fitting time
- ✓ Corrosion Grade 3 – Recommended for internal use



1720

## Specification Overview



Tested to EN1634



Max Door Weight up to 110kg



Opening Angle 120°

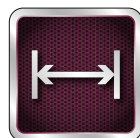

Max Door Width 1250mm



Universal Application



Adjustable Closing Speed



Adjustable Delayed Action



Power Size EN2-5



Adjustable Latch Speed



Guarantee



11205TS0  
CPR171218



Min Door 857mm fig30



Rut Lock

Cover

All dimensions shown are in mm.

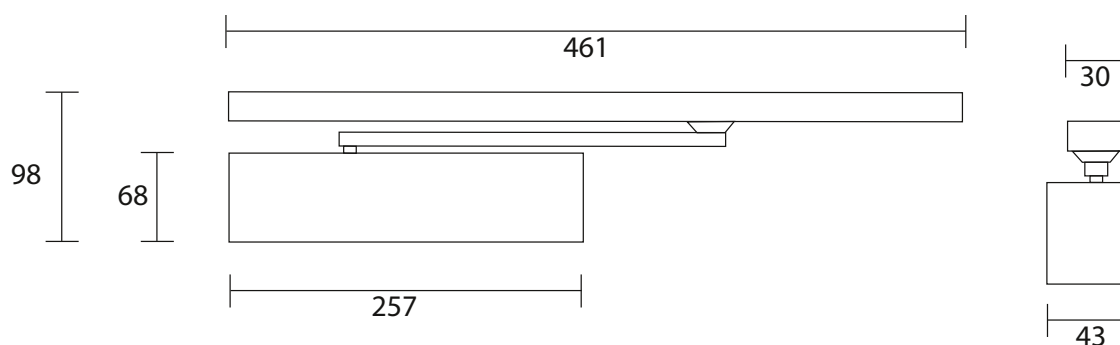

For fitting instructions see website - [www.rutlanduk.co.uk](http://www.rutlanduk.co.uk)

## Technical Information

### BS EN 1154 Classification

TS.11205 door closers have been independently tested to conform with the EN 1154 performance standard. They are CE marked and classified as follows:

3 8  $\frac{2}{5}$  1 1 3

### BS EN 1634 Fire Test

TS.11205 door closers have been tested to EN 1634 Fire Pressure Test for, 30 and 60 minutes on a TFTDoor and TFCDor.

### ADA Compliant

Fire doors shall have a minimum opening force allowable by the appropriate administration authority, and doors other than fire doors 5 pounds maximum opening force (22.2N) from push or pull side.

### UL Listed

The TS.11205 has been certified and labelled to the Underwriters' Laboratories (UL) testing, inspection, certification, auditing and validation.

## Options

- Mechanical hold open slide rail (*Not to be used on fire doors. Not covered by CE*)
- Back check available as a cushion stop in the rail
- For uninsulated doors see code in components list for intumescent kit

















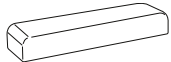





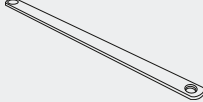





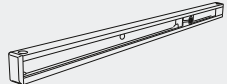

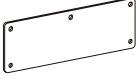
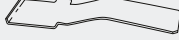

## Other Benefits

- BS8300 & ADA.cv door closer helping the less able (min door size 857mm)

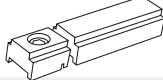



# TS.11205 Components

| Description                                                                                                                                                                               | EN Size | Finish                                                                                                 | Re-order Code | Product Code           | Box Qty |
|-------------------------------------------------------------------------------------------------------------------------------------------------------------------------------------------|---------|--------------------------------------------------------------------------------------------------------|---------------|------------------------|---------|
|  <p>TS.11205 cam action slide arm door closer combined unit (with SA.2 rail and connector bar - CB.5)</p> | 2-5     | Silver                | <b>12044</b>  | TS.11205.SR.2.SESE     | 6       |
|                                                                                                                                                                                           |         | Satin Nickel          | <b>12045</b>  | TS.11205.SR.2.SNPSNP   | 6       |
|                                                                                                                                                                                           |         | Polished Nickel       | <b>12042</b>  | TS.11205.SR.2.PNPPNP   | 6       |
|                                                                                                                                                                                           |         | Electro Brass         | <b>12043</b>  | TS.11205.SR.2.PVDPVD   | 6       |
|  <p>TS.11204 cam action with square cover</p>                                                             | 2-5     | Silver                | <b>12157</b>  | TS.11205DA.SR.2.SESE   | 6       |
|                                                                                                                                                                                           |         | Satin Nickel          | <b>12158</b>  | TS.11205DA.SR.2.SNPSNP | 6       |
|  <p>TS.11000 series semi radius cover</p>                                                                | -       | Silver                | <b>11291</b>  | SR.114.SE              | 25      |
|                                                                                                                                                                                           |         | Satin Nickel          | <b>11292</b>  | SR.114.SNP             | 25      |
|                                                                                                                                                                                           |         | Polished Nickel       | <b>11289</b>  | SR.114.PNP             | 25      |
|                                                                                                                                                                                           |         | Electro Brass         | <b>11290</b>  | SR.114.PVD             | 25      |
|                                                                                                                                                                                           |         | Antique Brass         | <b>12025</b>  | SR.114.AB              | 25      |
|  <p>TS11205 concealed door closer-to-slide arm connector bar options (single action not handed)</p>     | -       | Silver                | <b>11022</b>  | CB.5.SE                | 50      |
|                                                                                                                                                                                           |         | Satin Nickel        | <b>11023</b>  | CB.5.SNP               | 50      |
|                                                                                                                                                                                           |         | Polished Nickel     | <b>11020</b>  | CB.5.PNP               | 50      |
|                                                                                                                                                                                           |         | Electro Brass       | <b>11021</b>  | CB.5.PVD               | 50      |
|                                                                                                                                                                                           |         | Antique Brass       | <b>12023</b>  | CB.5.AB                | 50      |
| Optional Mounting Bracket                                                                                                                                                                 | -       | -                                                                                                      | <b>11179</b>  | MP.114                 | 10      |
|  <p>461mm long Slide Rail for surface or concealed fixing</p>                                          |         | Silver              | <b>11247</b>  | SA.2.SE                | 25      |
|                                                                                                                                                                                           |         | Satin Nickel Plate  | <b>11248</b>  | SA.2.SNP               | 25      |
|                                                                                                                                                                                           |         | Polished Nickel     | <b>11245</b>  | SA.2.PNP               | 25      |
|                                                                                                                                                                                           |         | Electro Brass       | <b>11246</b>  | SA.2.PVD               | 25      |
|                                                                                                                                                                                           |         | Antique Brass       | <b>12024</b>  | SA.2.AB                | 35      |
|  <p>Slide Rail Drop Plate</p>                                                                          |         | Silver                                                                                                 | <b>12154</b>  | SA.DP.SE               | 25      |
|                                                                                                                                                                                           |         | White                                                                                                  | <b>12007</b>  | SA.DP.WH               | 35      |
|  <p>Hold open device (Not for use on fire doors)</p>                                                   |         | Silver              | <b>11251</b>  | SA.HO                  | 25      |
|  <p>Cushion stop</p>                                                                                   |         | White cushion stop                                                                                     | <b>11249</b>  | SA.CS                  | 25      |
| <p>Fixing pack for the TS.11204</p>                                                                                                                                                       |         | Satin Nickel        | <b>11958</b>  | FIX.2.114.SNP          | 100     |
|                                                                                                                                                                                           |         | Polished Brass      | <b>11957</b>  | FIX.2.114.PVD          | 100     |
| <p>Intumescent Kit for uninsulated steel doors</p>                                                                                                                                        |         | Black               | <b>12407</b>  | IP.114SM               | 100     |
| <p>Anti-Ligature</p>                                                                                                                                                                      |         | Black               | <b>12075</b>  | FIX.AL                 | -       |
| <p>Slide Arm cover</p>                                                                                                                                                                    |         | Satin Nickel        | <b>12238</b>  | SAC.2.SNP              | 25      |
| <p>Stop Block</p>                                                                                                                                                                         |         | Black               | <b>11236</b>  | SA.1.BLOCK             | 25      |